

FAG

## QJ205-XL-MPA

Four-point contact bearing

Schaeffler ID:  
0192601480000Four point contact bearing QJ2..-XL-MPA,  
X-life, solid brass cage

X-life

## Technical information

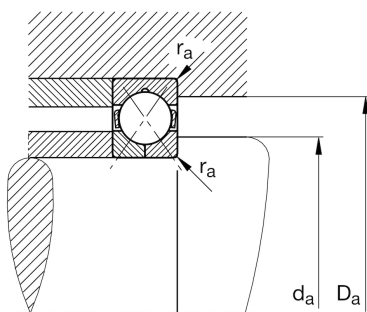
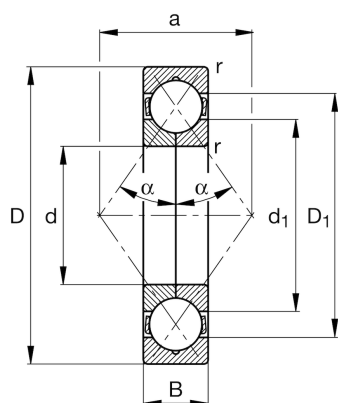

## Main Dimensions &amp; Performance Data

d	25 mm	Bore diameter
D	52 mm	Outside diameter
B	15 mm	Width
$C_r$	26.000 N	Basic dynamic load rating, radial
$C_{0r}$	18.800 N	Basic static load rating, radial
$C_{ur}$	1.300 N	Fatigue load limit, radial
$n_G$	28.000 1/min	Limiting speed
$n_{gr}$	12.300 1/min	Reference speed
	0,159 kg	Weight

## Dimensions

$r_{min}$	1 mm	Minimum chamfer dimension
$D_1$	43,1 mm	Shoulder diameter outer ring
$d_1$	33,9 mm	Shoulder diameter inner ring
a	27 mm	Distance between the apexes of the pressure cones
$\alpha$	35 °	Contact angle

## Mounting dimensions

$d_{a min}$	31 mm	Minimum diameter shaft shoulder
$D_{a max}$	46 mm	Maximum diameter of housing shoulder
$r_{a max}$	1 mm	Maximum fillet radius

## Temperature range

$T_{min}$	-30 °C	Operating temperature min.
$T_{max}$	150 °C	Operating temperature max.